

esybox mini³

ELECTRONIC PRESSURISATION SYSTEM



PERFORMANCE RANGE

The performance curves are based on kinematic viscosity values = 1 mm²/s and density equivalent to 1000 kg/m³. Curve tolerance according to ISO 9906.

GRAPHIC SELECTION TABLE

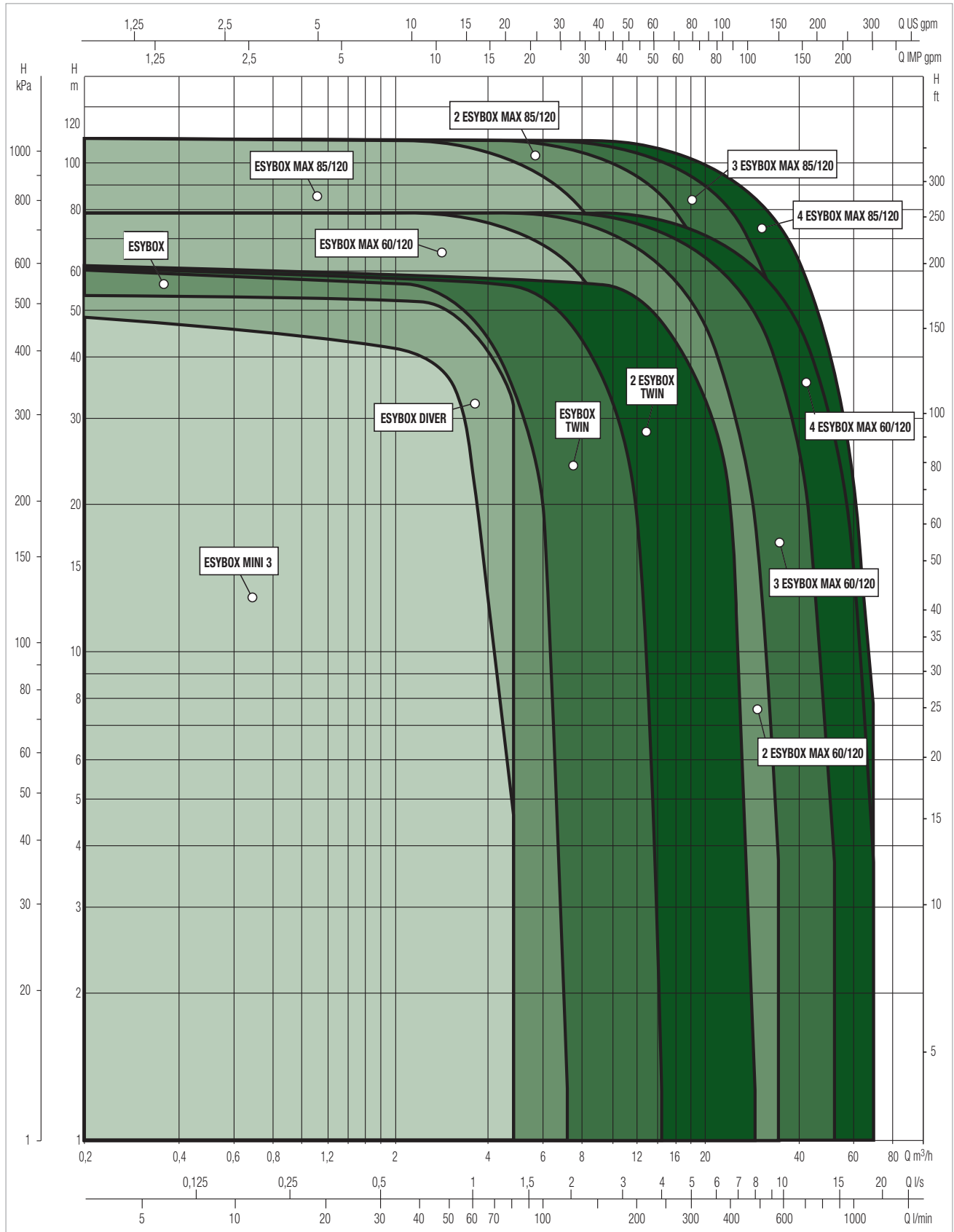

ESYBOX LINE

ELECTRONIC BOOSTER SETS

ESYBOX MINI ³

MODEL	Q=m ³ /h	0	0,6	1,2	1,8	2,4	3	3,6	4,2	4,8	5,4	6	6,6	7,2
	Q=l/min	0	10	20	30	40	50	60	70	80	90	100	110	120
ESYBOX MINI ³	H (m)	55	55	55	49	39	31	23	14	4				

ESYBOX

MODEL	Q=m ³ /h	0	0,6	1,2	1,8	2,4	3	3,6	4,2	4,8	5,4	6	6,6	7,2
	Q=l/min	0	10	20	30	40	50	60	70	80	90	100	110	120
ESYBOX	H (m)	65	63,5	61,5	59,5	57	53	48	41,5	35	27,5	19	10	2

ESYBOX DIVER

MODEL	Q=m ³ /h	0	0,6	1,2	1,8	2,4	3	3,6	4,2	4,8	5,4	6	6,6	7,2
	Q=l/min	0	10	20	30	40	50	60	70	80	90	100	110	120
ESYBOX DIVER	H (m)	55	55	55	55	55	55	53	44	34	26	17	7,5	

ESYBOX TWIN

MODEL	Q=m ³ /h	0	1,2	2,4	3,6	4,8	6,0	7,2	8,4	9,6	10,8	12	13,2	14,4
	Q=l/min	0	20	40	60	80	100	120	140	160	180	200	220	240
2 ESYBOX WITH ESYTWIN	H (m)	65	63,5	61,5	59,5	57	53	48	41,5	35	27,5	19	10	2

MODEL	Q=m ³ /h	0	2,4	4,8	7,2	9,6	12	14,4	16,8	19,2	21,6	24	26,4	28,8
	Q=l/min	0	40	80	120	160	200	240	280	320	360	400	440	480
2 X 2 ESYBOX WITH ESYTWIN	H (m)	65	63,5	61,5	59,5	57	53	48	41,5	35	27,5	19	10	2

ESYBOX MAX

MODEL	Q=m ³ /h	0,0	2,4	3,6	4,8	6,0	7,2	8,4	9,6	10,8	12,6	14,4	17,4
	Q=l/min	0	40	60	80	100	120	140	160	180	210	240	290
ESYBOX MAX 60/120 M	H (mt)	80	79,5	77,1	73,4	68,5	62	55,5	48,2	41	30,5	21	4
ESYBOX MAX 60/120 T		80	79,5	77,1	73,4	68,5	62	55,5	48,2	41	30,5	21	4
ESYBOX MAX 85/120 T		113	110	106,5	101	93	84	75	65,5	56,7	43,5	31	8,5

MODEL	Q=m ³ /h	0	4,8	7,2	9,6	12	14,4	16,8	19,2	21,6	25,2	28,8	34,8
	Q=l/min	0	80	120	160	200	240	280	320	360	420	480	580
2 ESYBOX MAX 60/120 M	H (mt)	80	79,5	77,1	73,4	68,5	62	55,5	48,2	41	30,5	21	4
2 ESYBOX MAX 60/120 T		80	79,5	77,1	73,4	68,5	62	55,5	48,2	41	30,5	21	4
2 ESYBOX MAX 85/120 T		113	110	106,5	101	93	84	75	65,5	56,7	43,5	31	8,5

MODEL	Q=m ³ /h	0	7,2	10,8	14,4	18	21,6	25,2	28,8	32,4	37,8	43,2	52,2
	Q=l/min	0	120	180	240	300	360	420	480	540	630	720	870
3 ESYBOX MAX 60/120 M	H (mt)	80	79,5	77,1	73,4	68,5	62	55,5	48,2	41	30,5	21	4
3 ESYBOX MAX 60/120 T		80	79,5	77,1	73,4	68,5	62	55,5	48,2	41	30,5	21	4
3 ESYBOX MAX 85/120 T		113	110	106,5	101	93	84	75	65,5	56,7	43,5	31	8,5

MODEL	Q=m ³ /h	0	9,6	14,4	19,2	24	28,8	33,6	38,4	43,2	50,4	57,6	69,6
	Q=l/min	0	160	240	320	400	480	560	640	720	840	960	1160
4 ESYBOX MAX 60/120 M	H (mt)	80	79,5	77,1	73,4	68,5	62	55,5	48,2	41	30,5	21	4
4 ESYBOX MAX 60/120 T		80	79,5	77,1	73,4	68,5	62	55,5	48,2	41	30,5	21	4
4 ESYBOX MAX 85/120 T		113	110	106,5	101	93	84	75	65,5	56,7	43,5	31	8,5

ESYBOX MINI³

ELECTRONIC PRESSURISATION SYSTEM



TECHNICAL DATA

Flow rate: 4,8 m³/h

Head: 55 m

Type of pumped liquid : Clean, free from solid or abrasive substances, non-viscous, non-aggressive, non-crystallized and chemically neutral

Liquid temperature:

From +0°C to +35°C for domestic use

From +0°C to +40°C for other use

Maximum ambient temperature: +50°C

Maximum Suction depth: 8 m

Maximum Operation pressure: 7,5 bar / 750 kPa

Motor protection class: IP X4

Motor insulation class: F

Impeller material: Technopolymer

Single phase power input: 230 V 50 Hz

Power cord (m) and plug: 1,5 meter with power plug

Type of installation: Fixed, vertically, horizontally or on the wall with special accessories (supplied separately)

Certification: WRAS, ACS

Electronic self-priming multi-impeller pressurization system for rainwater reuse, ground water, gardening and irrigation and for watering small gardens in residential building service. Possibility of remote control thanks to the DConnect service (with DConnect Box supplied separately).

CONSTRUCTION FEATURES OF THE PUMP

Self-priming multi-impeller pump. Protective hull in sound-absorbing ABS. Technopolymer impellers. Motor shaft in stainless steel. Non-return valve and integrated expansion vessel.

CONSTRUCTION FEATURES OF THE MOTOR

Motor cooled by pumped liquid, stainless steel motor jacket. Complete with power cable and plug.

CONSTRUCTION FEATURES OF THE ELECTRONIC

Adjustable display. The variable frequency drive function saves energy and protects against water hammer. Guided procedure for the first start-up, easy configuration, possibility to view the alarm history.

MATERIALS

N°	PARTS	MATERIALS
1	MOTOR SLEEVE	STAINLESS STEEL AISI 304
2	O-RING	NBR
4	MOTOR BODY	PP OMO 30% GF
5	MECHANICAL SEAL DISC	PA 6.6 30% GF
9	MECHANICAL SEAL	CARBON IMPREGNATED RESIN / CERAMIC / NBR
12	DIFFUSER	NORYL
14	IMPELLER	NORYL
21	SUCTION BODY	PP OMO 30% GF
22	INSERT 1"	BRASS
23	SHUTTER SPRING	STAINLESS STEEL AISI 303
25	SELFPRIMING SHUTTER	POM
26	1" PLUG	PP OMO 30% GF
34	NON RETURN VALVE	TECHNOPOLYMER / RUBBER / STEEL
41	1" 1/4 PLUG	PA 6.6 30% GF
43	HEAT SINK	BRASS
45	DELIVERY BODY	PP OMO 30% GF
46	INSERT 1"	BRASS
48	VESSEL 1L	TECHNOPOLYMER / RUBBER
51	FLOWMETER WHEEL	POM
56	PRESSURE SENSOR BODY	TECHNOPOLYMER
69	1" PLUG	PA 6.6 30% GF

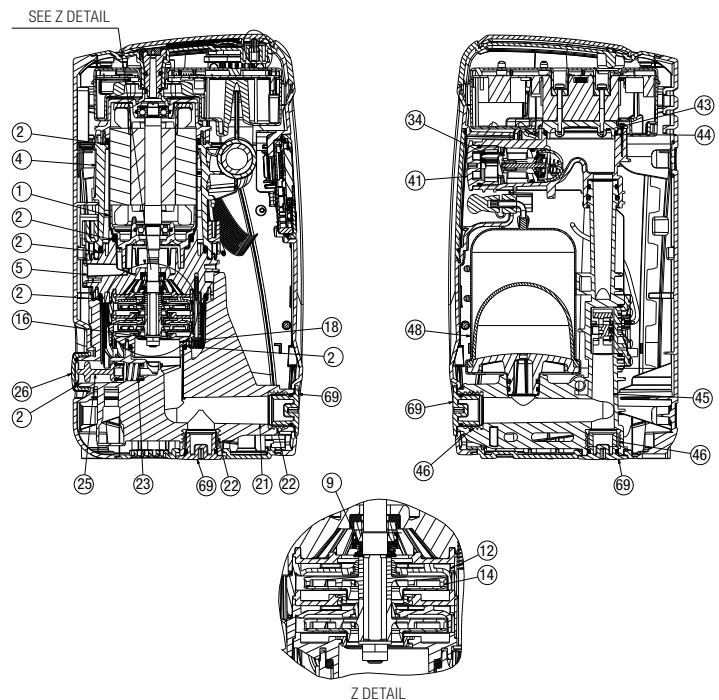

ESYBOX MINI³ - ELECTRONIC PRESSURISATION SYSTEM

Liquid temperature range: from 0°C a +35°C for domestic use - from 0°C a +40°C for other uses. Maximum ambient temperature: +50°C

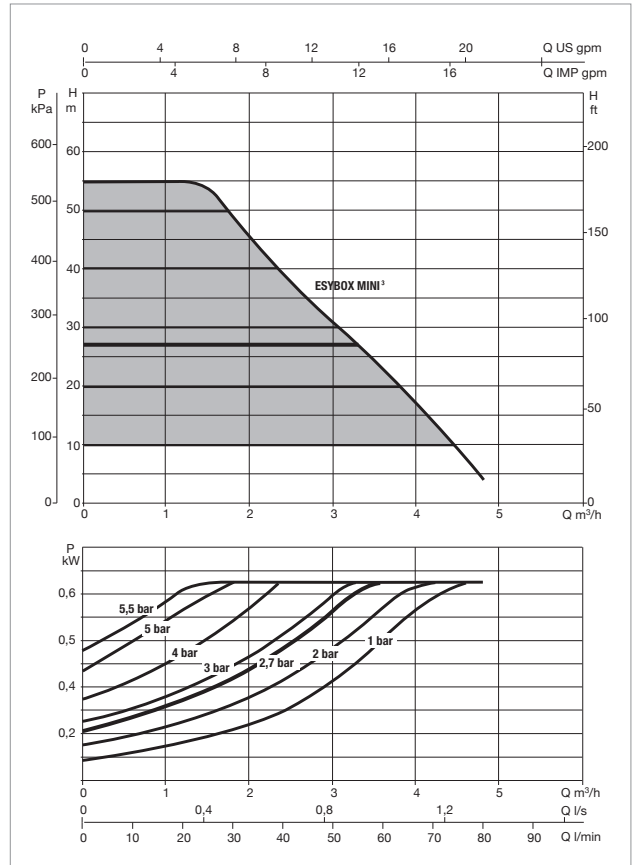
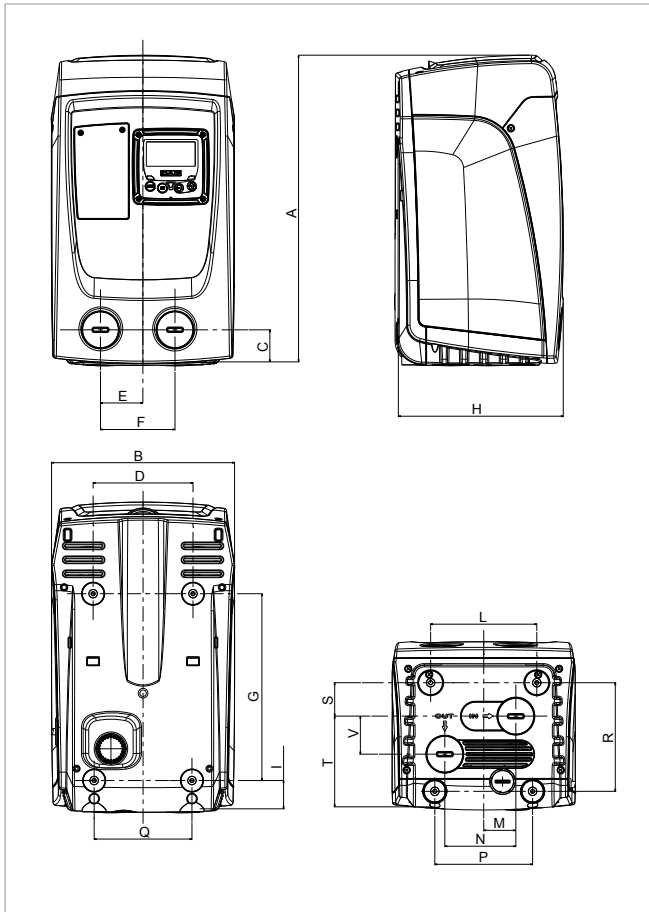





The performance curves are based on the kinematic viscosity values = 1 mm²/s and density equivalent to 1000 kg/m³. Curve tolerance according to ISO 9906.





MODEL	ELECTRICAL DATA				
	N° IMPELLER	POWER INPUT 50/60 Hz	P1 MAX		In A
			kW	HP	
ESYBOX MINI ³	3	1x220-240V ~	0,85	1,1	4,8
ESYBOX KIWA ³	3	1x220-240V ~	0,85	1,1	4,8



MODEL	A	B	C	D	E	F	G	H	I	L	M	N	P	Q	R	S	T	V	DNA	DNM	PACKING DIMENSIONS			WEIGHT Kg
																					L/A	L/B	H	
ESYBOX MINI ³	439	263	46	143	60,7	106,7	279,5	236	40,5	152	46	101,7	140	140	155,5	47,8	133	54,5	1"	1"	300	500	320	14,6
ESYBOX KIWA ³	439	263	46	143	60,7	106,7	279,5	236	40,5	152	46	101,7	140	140	155,5	47,8	133	54,5	1"	1"	300	500	320	14,6

ACCESSORIES

ESYBOX MINI³

D CONNECT	DESCRIPTION
	<p>DCONNECT BOX</p> <p>The DConnect Box is suitable for remote control and management of large installations, and can connect up to eight DAB products. It can also be used on products that are already installed and only requires permanent Internet access at the system location. Monitoring is carried out via the DConnect app.</p> <div style="text-align: right;">    </div>

D CONNECT	DESCRIPTION
	<p>DCONNECT BOX 2</p> <p>Thanks to DConnect Box 2 and the new App you can check the pump, set the starting and stopping parameters, view the details of alarms and monitor the status of the system directly on your smartphone.</p> <p>With DConnect Box 2, you'll be able to access Dab's cloud service.</p> <div style="text-align: right;">    </div>

	DESCRIPTION
	<p>KIT PIPE UNION 3PCS MF 1" WITH O-RING</p> <p>Kit consisting of 2 x 3-piece unions, to facilitate the connection of Eskybox mini³ to the system</p>
 <p>18,4 x 14,3 cm</p>	<p>ESYWALL</p> <p>Kit complete with brackets, screws, dowels and two accessories for absorption of vibrations.</p>

KIT OUTDOOR	DESCRIPTION
	<p>ESYCOVER + ESYGRID</p> <p>KIT OUTDOOR ESKYBOX MINI³ Consisting of Eskycover + Eskygrid, which allows the installation of ESKYBOX MINI³ outside, protecting it from rain and the entry of foreign bodies. Vertical installation only.</p>

DNA[®]

PUMPS SELECTOR



On-line selection tool

 **DAB PUMPS LTD.**
6 Gilbert Court
Newcomen Way
Severalls Business Park
Colchester
Essex
CO4 9WN - UK
salesuk@dwtgroup.com
Tel. +44 0333 777 5010

 **DAB PUMPS IBERICA S.L.**
Calle Verano 18-20-22
28850 - Torrejón de Ardoz - Madrid
Spain
Info.spain@dwtgroup.com
Tel. +34 91 6569545
Fax: +34 91 6569676

 **DAB PUMPS SOUTH AFRICA (PTY) LTD**
Twenty One industrial Estate,
16 Purlin Street, Unit B, Warehouse 4
Olifantsfontein -1666 - South Africa
info.sa@dwtgroup.com
Tel. +27 12 361 3997

 **DAB PUMPS (QINGDAO) CO. LTD.**
No.40 Kaituo Road, Qingdao Economic & Technological
Development Zone
Qingdao City, Shandong Province - China
PC: 266500
sales.cn@dwtgroup.com
Tel. +86 400 186 8280
Fax +86 53286812210

 **DAB PUMPS BV**
"Hofveld 6 C1
1702 Groot Bijgaarden - Belgium
info.belgium@dwtgroup.com
Tel. +32 2 4668353

 **DAB PUMPS HUNGARY KFT.**
H-8800
Nagykanizsa, Buda Ernő u.5
Hungary
Tel. +36 93501700

 **DAB PUMPS POLAND Sp. z o.o.**
Ul. Janka Muzykanta 60
02-188 Warszawa - Poland
polska@dabpumps.com.pl

 **DAB PUMPS DE MÉXICO, S.A. DE C.V.**
Av Amsterdam 101 Local 4
Col. Hipódromo Condessa,
Del. Cuauhtémoc CP 06170
Ciudad de México
Tel. +52 55 6719 0493

 **DAB PUMPS B.V.**
Albert Einsteinweg, 4
5151 DL Drunen - Nederland
info.netherlands@dwtgroup.com
Tel. +31 416 387280
Fax +31 416 387299

 **OOO DAB PUMPS**
Novgorodskaya str. 1, block G
office 308, 127247, Moscow - Russia
info.russia@dwtgroup.com
Tel. +7 495 122 0035
Fax +7 495 122 0036

 **DAB PUMPS OCEANIA PTY LTD**
426 South Gippsland Hwy,
Dandenong South VIC 3175 - Australia
info.oceania@dwtgroup.com
Tel. +61 1300 373 677

 **DAB PUMPS GMBH**
Am Nordpark 3
D - 41069 Mönchengladbach - Germany
info.germany@dwtgroup.com
Tel. +49 2161 47388-0
Fax +49 2161 47388-36

 **DAB PUMPS INC.**
3226 Benchmark Drive
Ladson, SC 29456 - USA
info.usa@dwtgroup.com
Tel. 1-843-797-5002
Fax 1-843-797-3366

 **PT DAB PUMPS INDONESIA**
Satrio Tower lantai 26
unit C-D, Jl. Prof. Dr. Satrio Kav. C4,
Kel. Kuningan Timur, Kec. Setiabudi, Kota Adm.
Jakarta Selatan, Prov. DKI Jakarta. - Indonesia
Tel. +62 2129222850